

- GB** INSTALLATION INSTRUCTION  
**MUDFLAPS**
- D** EINBAUANLEITUNG  
**SCHMUTZFÄNGER**
- E** INSTRUCCIONES DE MONTAJE  
**FALDILLAS GUARDABARROS**
- F** NOTICE DE MONTAGE  
**BAVETTES**
- I** ISTRUZIONI DI MONTAGGIO  
**BAVETTA PARASPRUZZI**
- P** INSTRUÇÕES DE MONTAGEM  
**COLETOR DE SUJEIRA**
- NL** INBOUW-INSTRUCTIE  
**SPATLAPPEN**
- DK** MONTERINGSVEJLEDNING  
**STÆNKLAPPER**
- N** MONTERINGSVEILEDNING  
**SMUSSFANGER**
- S** MONTERINGSANVISNING  
**STÄNKSKYDD**
- SF** ASENNUSOHJE  
**ROISKELÄPPÄ**
- CZ** NÁVOD K MONTÁŽI  
**LAPAČ NEČISTOT**
- H** BESZERELÉSI UTASÍTÁS  
**SÁRHÁNYÓ**
- PL** INSTRUKCJA INSTALOWANIA  
**FARTUCH BŁOTNIKA**
- GR** ΟΔΗΓΙΕΣ ΤΟΠΟΘΕΤΗΣΗΣ  
**Λασπωτήρες χρήσης**

Subject to alteration without notice  
 Technische Änderungen vorbehalten  
 Reservadas modificaciones técnicas  
 Sous réserve de modifications techniques  
 Con riserva di apportare modifiche tecniche  
 Reservamo-nos o direito a alterações técnicas  
 Technische wijzigingen voorbehouden  
 Med forbehold for tekniske índringer  
 Tekniske forendringer forbeholdes  
 Med reservation för tekniska ändringar  
 Tekniset muutokset pidätetään  
 Technické zmeny vyhradeny  
 A változtatások technika jogát fenntartjuk  
 Zmiany techniczne zastrzeżone  
 Επιφυλασσομεθα για αλλαγες

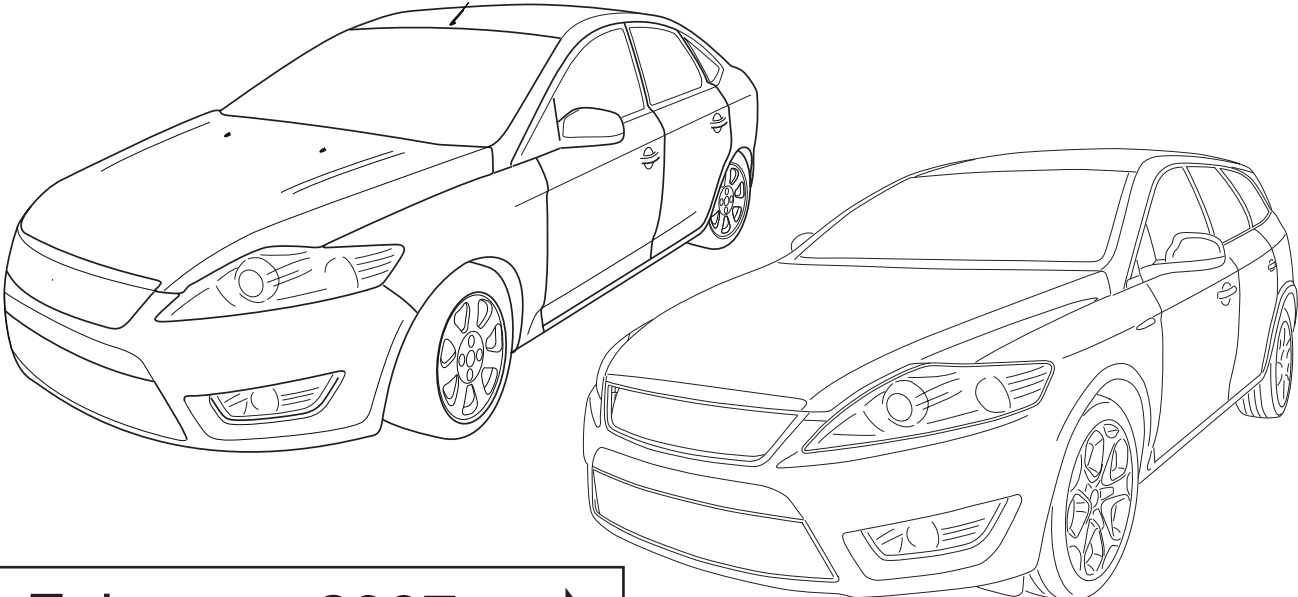

Fahrzeug 2007

➔

ARCHIV

Teilenummer	Freigabenummer	08/08/2008	1/5
-------------	----------------	------------	-----

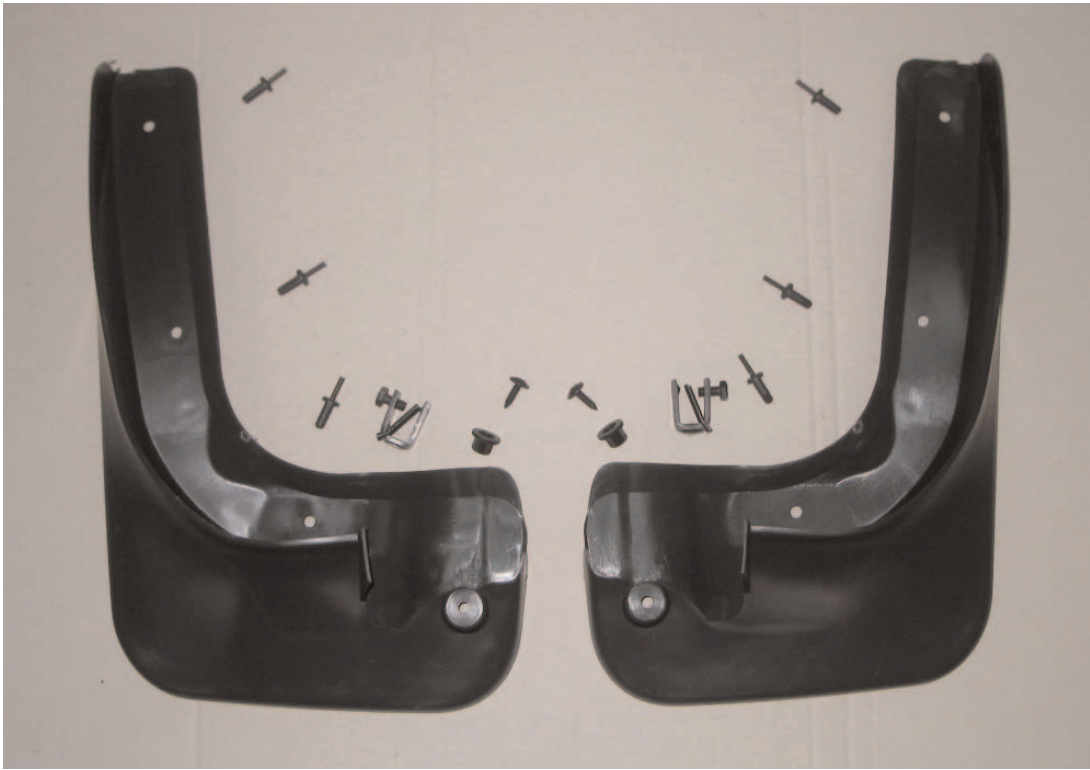

**Teil A plus Befestigungsteile**

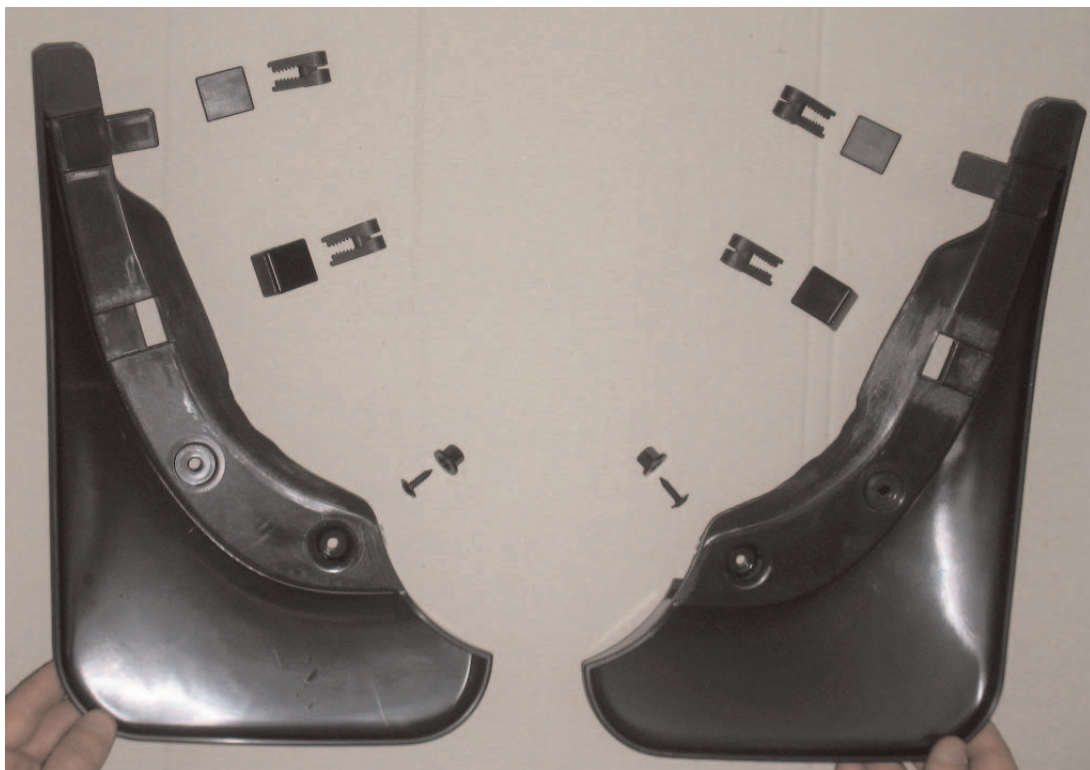

**Teil F plus Befestigungsteile**



- (GB) Wipe Clean
- (D) Reinigen
- (E) Limpiar
- (F) Nettoyer
- (I) Ripulire
- (P) Limpiar
- (NL) Zuiver maken
- (DK) Aftørring
- (N) Rengjøring
- (S) Rengör
- (SF) Puhdistä
- (CZ) Očistit
- (H) Tisztítsa meg
- (PL) Oczyszczyć
- (GR) Καθαρίσμα



- (GB) Movement Arrow
- (D) Bewegungspfeil
- (E) Flecha de movimiento
- (F) Flèche de mouvement
- (I) Freccia di movimento
- (P) Flexa de movimento
- (NL) Richtingspijl
- (DK) Bevægelsespil
- (N) Bevegelsespil
- (S) Rörelsepil
- (SF) Liikesuuntanuoli
- (CZ) Šipka pohybu
- (H) Mozgásirányjelző nyíl
- (PL) Strzałka kierunku ruchu
- (GR) Βέλος κίνησης



- (GB) Location/Position Arrow
- (D) Positionspfeil
- (E) Flecha de posición
- (F) Flèche de Position
- (I) Freccia di posizione
- (P) Flexa de posição
- (NL) Lokatie/Positie pijl
- (DK) Lokaliseringspil
- (N) Posisjonspil
- (S) Positionpil
- (SF) Paikannusnuoli
- (CZ) Šipka na pozici
- (H) Helyzetjelző nyíl
- (PL) Strzałka położenia
- (GR) Βέλος θέσης

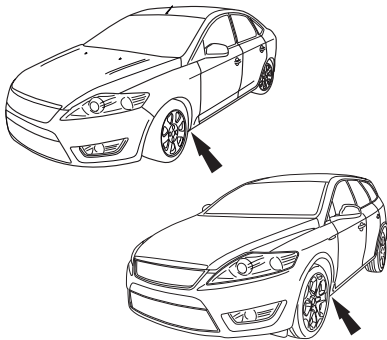

**A**

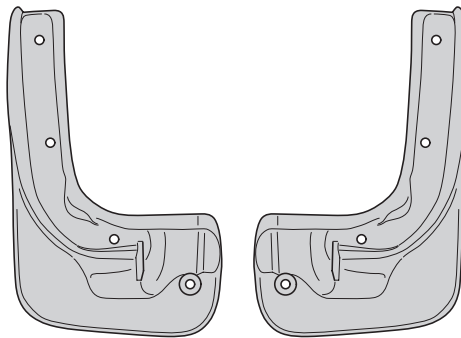

**B**

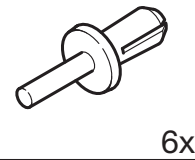

6x

**C**

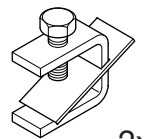

2x

**D**



2x

**E**



2x

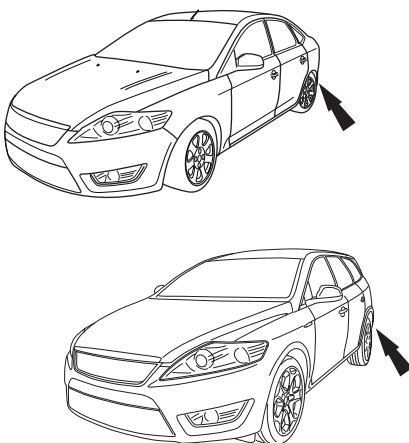

**F**

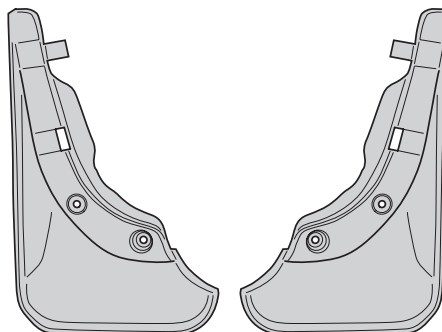

**D**

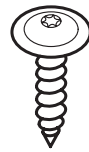

2x

**E**



2x

**G**

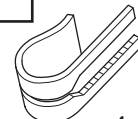

4x

**H**



2x

**I**

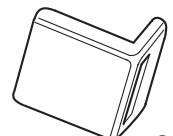

2x

**Zeichnungen 1 - 4, 6 + 8**  
**angepasste Zeichnungen aus unserem Kundenarchiv**



**Zeichnung 5 + 7**

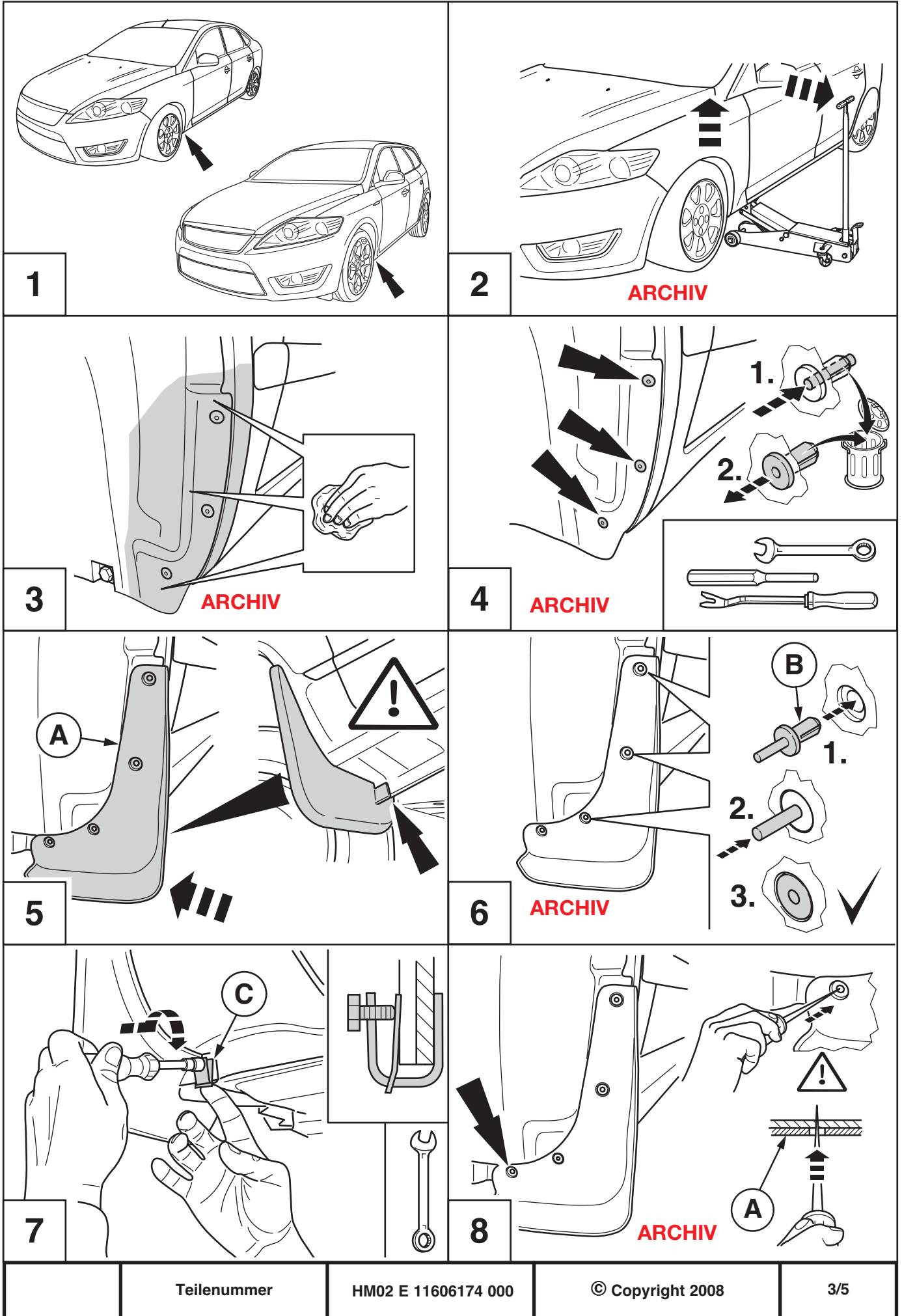

1

2

3

4

5

6

7

8

ARCHIV

ARCHIV

ARCHIV

ARCHIV

ARCHIV

Teilenummer

HM02 E 11606174 000

© Copyright 2008

3/5

**Zeichnungen 9, 10, 11, 16  
angepasste Zeichnungen aus unserem Kundenarchiv**



**Zeichnung 12 + 13**



**Zeichnung 14 + 15**

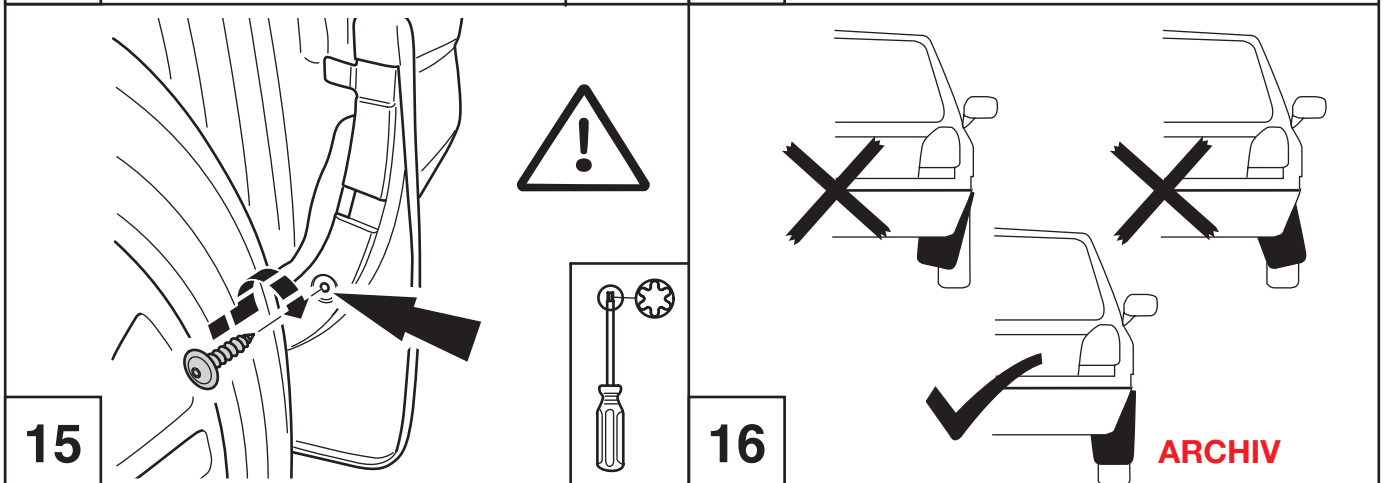
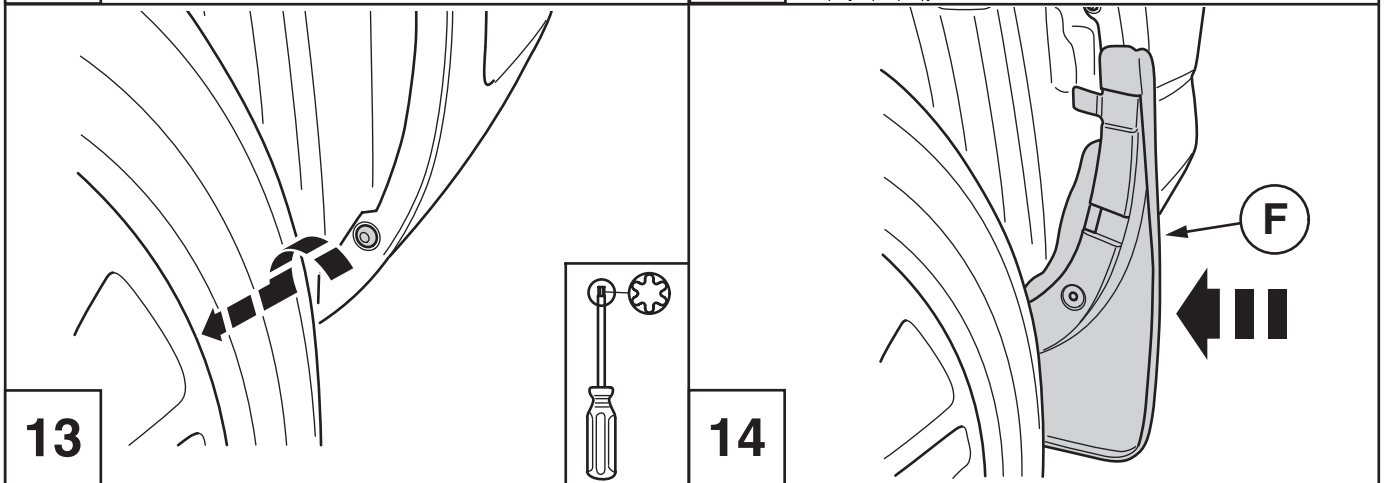
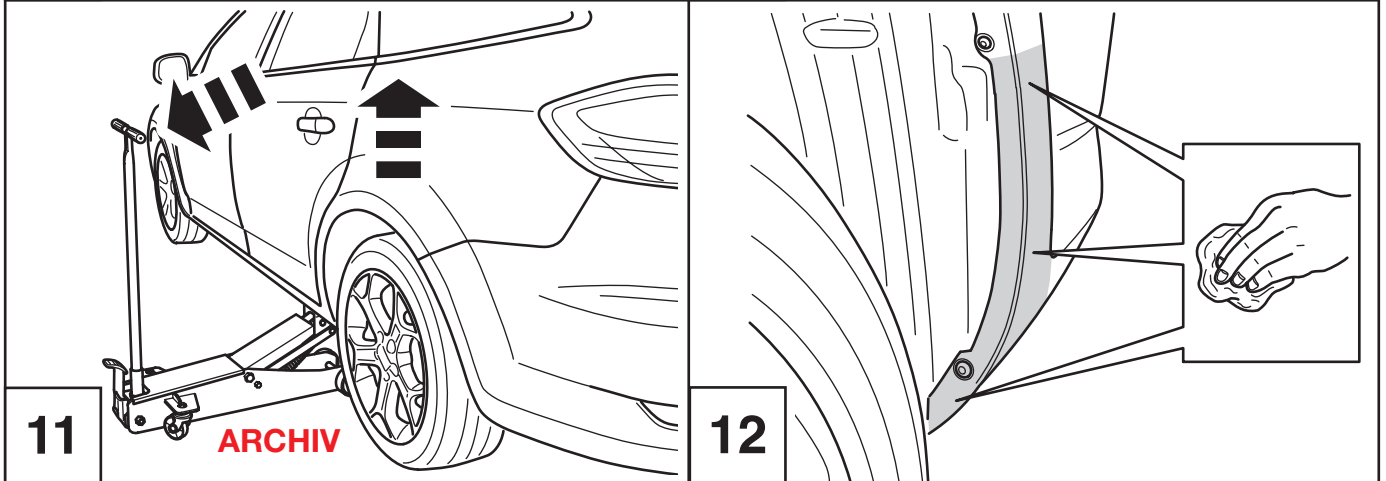
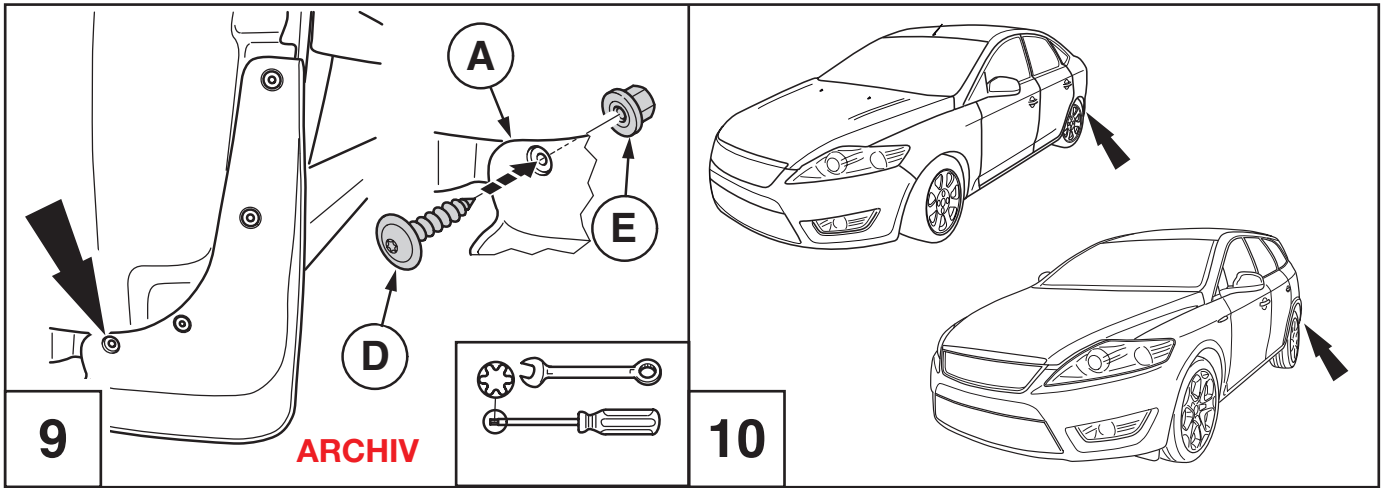



**Zeichnung 17**



**Zeichnung 18**



**Zeichnung 19**



**Zeichnung 20**



